

SPECIFICATION

Product: 450W Modular Floodlight



1.Main Features

- ▶ Different beam angle 110°, 25°, 60°, 90°, 130° x 60° Asymmetric.
- ▶ Meanwell ELG drivers.
- ▶ Die-casting Aluminum housing with AkzoNobel powder coating.
- ▶ Long lifetime over 50,000 hrs, extremely low maintenance cost.
- ▶ CRI>80, CRI>70 optional.
- ▶ Osram/ Lumileds 3030/5050, LEDs up to 155lm/Watt @80Ra.
- ▶ Dali, 1-10V, PWM Dimmable available.
- ▶ 5 years warranty.
- ▶ Suitable for sport field, warehouse, gymnasium, workshop, Gas stations, Toll stations, Parking area, etc.



2. Dimension

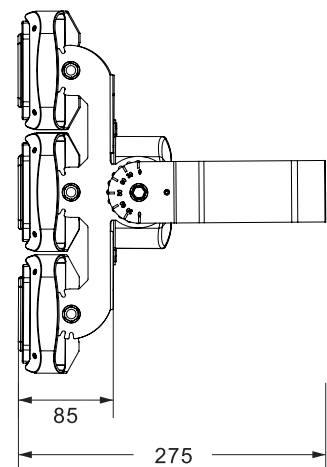
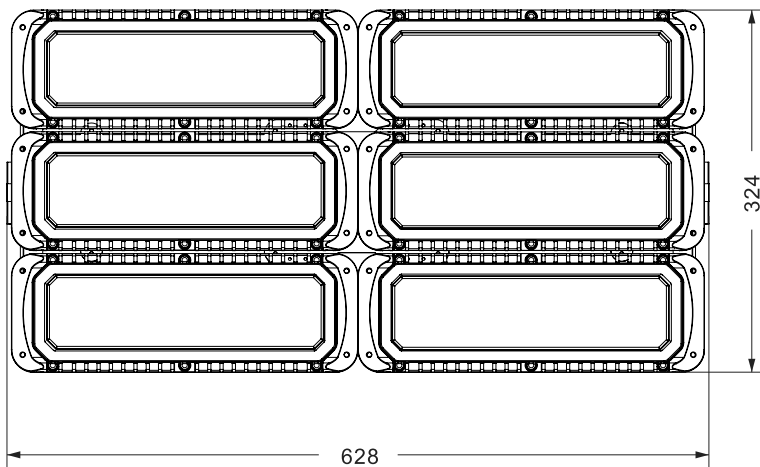

3. Technical Data

Model	MFL450W30-110	MFL450W50-25	MFL450W50-60	MFL450W50-90	MFL450W50-130x60
Light Source	Osram/ Lumileds 3030 2D	Osram/ Lumileds 5050	Osram/ Lumileds 5050	Osram/ Lumileds 5050	Osram/ Lumileds 5050
Luminous flux(lm)	58100	51800	51800	53100	57600
Beam Angle	110°	25°	60°	90°	130°x60°
Optical Cover	Clear/Foggy Glass	PC Lens	PC Lens	PC Lens	PC Lens
Input Voltage (V)	100-240VAC 50/60Hz		IP Class	IP65	
LED Power (W)	427		Housing	Die-casting Aluminum	
System Power (W)	459		Working Temperature (°C)	-20 to +50	
Power Factor	>0.95		Working Humidity(RH%)	10-90	
System Efficiency (lm/W)	115-130		Power Cable	3x1.5mm ² H07RN-F	
Color Temperature (K)	3000/4000/5700		Net Weight (Kg)	13.4(Glass)/12.9(PC Lens)	
CRI	>80 (3030 LEDs) >70 (5050 LEDs)		Dimension of Outer Carton(cm)	67.5*39.5*20.5 (1pcs/carton)	
Safety Standards	IEC 60598-2-5: 2015; IEC 60598-1: 2014; IEC 62031: 2008 + A1: 2012 + A2: 2014; EN 60598-2-5: 2015; EN 60598-1: 2015; EN 62031: 2008 + A1: 2013 + A2: 2015; EN 62493: 2015; AS/NZS 60598.2.5: 2002; AS/NZS 60598.1: 2017				
EMC Standards	EN 55015:2013+A1:2015; EN 61547:2009; EN 61000-3-2:2014; EN61000-3-3:2013				

4. Luminous Intensity Distribution Diagram

MFL450W30-110

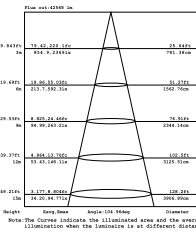
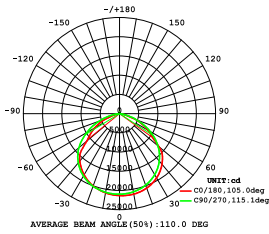

MFL450W50-25

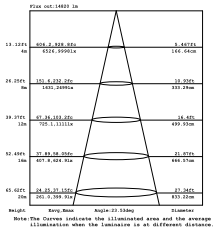
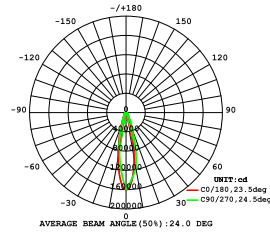

MFL450W50-60

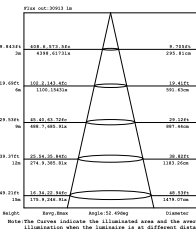
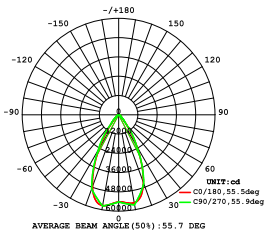

MFL450W50-90

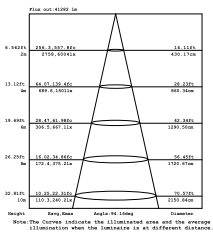
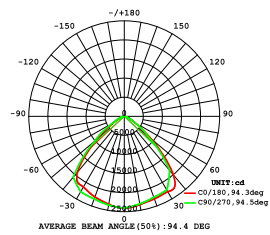

MFL450W50-130x60

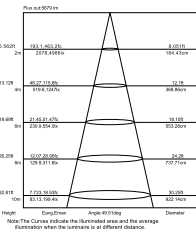
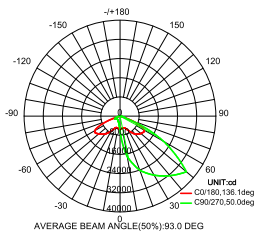

5. Installation

Please refer to Installation Instruction.